

Instructions

Pressure Controls PS12CN

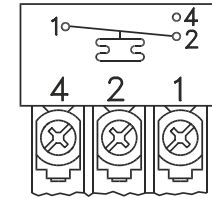
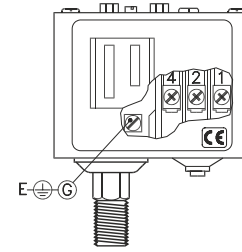
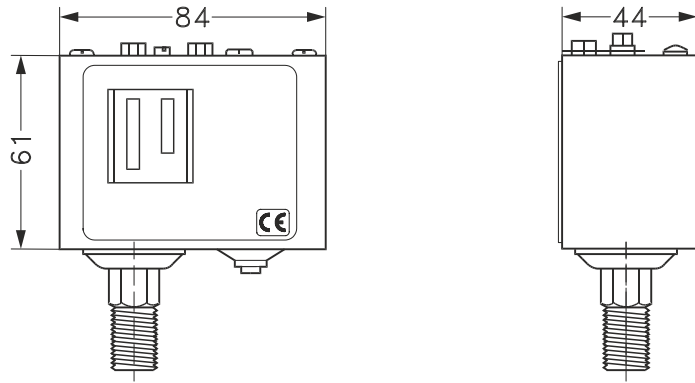

Contact system with standard AG contacts
Single pole changeover switch (SPDT)

Contact system with gold contacts
Single pole changeover switch (SPDT)

Alternating current:

- AC-1: 16, 400 V
- AC-3: 16A, 400 V
- AC-15: 10A, 400 V

Direct current:
DC-13: 12W, 220 V

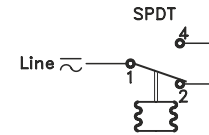

Alternating current:

- AC-1: 10, 400 V
- AC-3: 6A, 400 V
- AC-15: 4A, 400 V

Direct current:
DC-13: 12W, 220 V

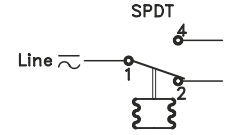

t_1 min. $-40\text{ }^\circ\text{C}$
 t_1 max. $65\text{ }^\circ\text{C}$

t_2 min. $-40\text{ }^\circ\text{C}$
 t_2 max. $100\text{ }^\circ\text{C}$

P_{est} max.
PS12CN1: 22 bar

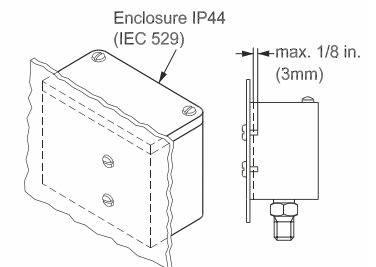
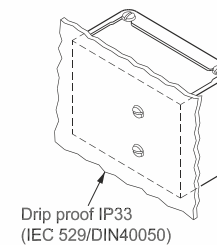
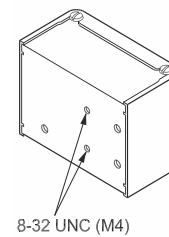
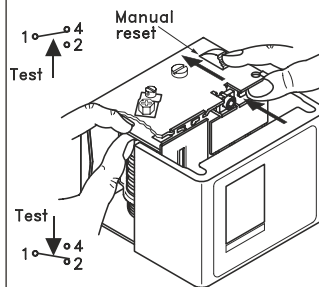
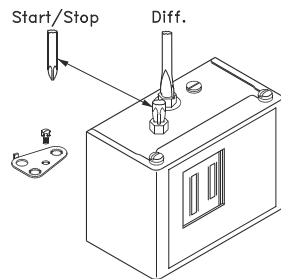
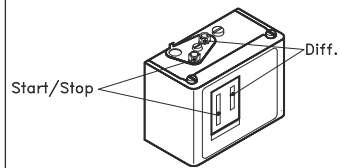
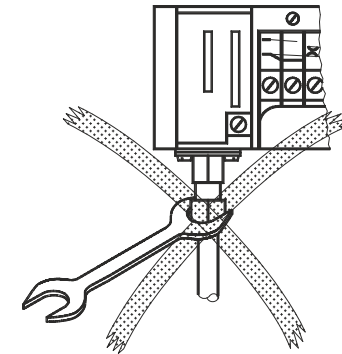
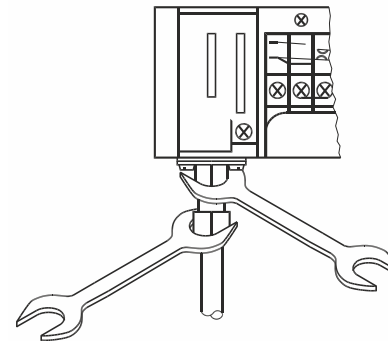
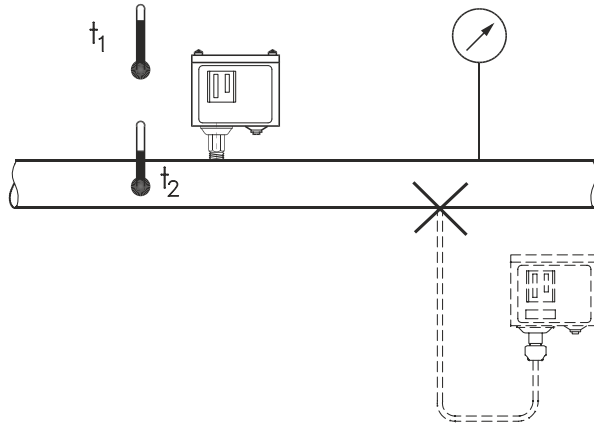

CAUTION: The mounting panel must be plane to avoid damage of control