

Características técnicas - Technical characteristics

- Escala de regulación - Regulation scale:..... de / from 6°C a / to 30°C
- Posición Y (calibrado) - Y Position (gaged): 20°C ±1°C
- Diferencial - Differential:..... 1.0°C ±0.5°C
- Temperatura de trabajo - Working temperature:..... 6°C a / to 30°C
- Temperatura almacenaje - Storage temperature:..... max. 50°C
- Grado de polución - Ingress Pollution:..... 2
- Categoría de resistencia al calor y fuego - Heat & fire resistance:..... D
- Tensión de impulso nominal - Assigned pulse voltage:..... 2.500V.
- Poder de ruptura - Breakage power **Acción tipo 1C** TA 3002, 12, 05, 06 :..... 15 (2.5)A 250V... 24V≈.
- Acción tipo 1B** TA 3007:..... 10 (2.5)A 250V... 24V≈.
- TA 3008:..... 6 (1.5)A 250V... 24V≈.



CLASE 2

T35

IP20

IMPORTANTE

Antes de quitar el capot, para acceder a las conexiones, asegurarse de desconectar la tensión.

El termostato debe instalarse sobre una superficie lisa y libre de residuos de pintura, yeso, etc. y nunca detrás de una puerta. Para instalaciones a > 1000 mts. s.n.m. Los valores de calibración no están asegurados.

Los contactos de salida no están protegidos, es responsabilidad del instalador el incorporar la protección eléctrica (homologada) adecuada a la instalación.

Reservado el derecho de modificación sin previo aviso.

IMPORTANT

Before removing the cover to reach terminals be sure that conductors to connect aren't supplied.

This thermostat must be settled over a completely plain and clean of remainders of painting, gypsum, etc. Surface, and never behind a door. Installations over >1000 mts a.s.l. the calibration values are not assured.

The leaving switches are not protected, the installer has the responsibility of incorporating the electric protection (homologated) appropriate to the installation.

We reserve the right to make modifications without prior notice.



Condiciones de Garantía

Este aparato tiene 3 años de garantía, ella se limita a la reposición de la pieza defectuosa. No incluye portes

Declinamos toda responsabilidad en los aparatos deteriorados, resultado de una mala manipulación.

No se incluye en la garantía:

- Los aparatos cuyo número de serie haya sido deteriorado, borrado o modificado.
- Los aparatos cuya conexión o utilización no hayan sido ejecutados conforme a las indicaciones adjuntas al aparato.
- Los aparatos modificados sin previo acuerdo con el fabricante.
- Los aparatos cuyo deterioro sea consecuencia de choques o emanación líquida o gaseosa.
- Ver resto de condiciones generales en web.

Conditions of Guarantee

This equipment has a 3 years guarantee, which means it only replaces the faulty part. Ports not included

We do not take any responsibility for deteriorated equipment, which are a result of bad handling.

The guarantee does not include:

- Equipment with deteriorated, worn or modified serial number.
- Equipment whose connection or use has not been carried out in accordance with the indications attached to equipment.
- Equipment modified without prior agreement from manufacturer.
- Equipment whose deterioration is due to bangs or spillage of liquid or gas.
- For the rest of general conditions visit our web.

Usuario-Instalador / User-Installer

Nombre - Name:

Apellido - Surname:

Dirección - Address:

Población - Town:

Código Postal - Postal Code:

Teléfono - Telephone:

Termostato - Thermostat:

Fecha de compra - Date of purchase:

Devolver esta hoja a / Return this sheet to:

SONDER REGULACIÓN S.A.
Avda. La Llana 93.
P.I. "La Llana" 230
08191 RUBÍ (Barcelona)
SPAIN
www.sonder.es



TA 3002 - Código: 10.095



TA 3012 - Código: 10.281



TA 3002 Braille - Código: 10.254

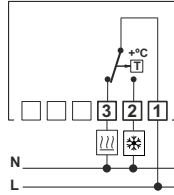

Heating Load, Cooling Load

TA 3005 - Código: 10.181

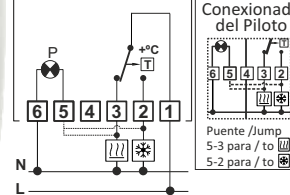

Heating Load, Cooling Load, Pilot Light

TA 3006 - Código: 10.107

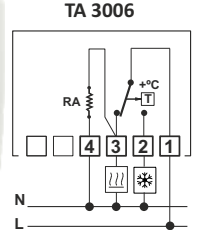

Heating Load, Cooling Load, Acceleration Resistance

TA 3007 - Código: 10.096



TA 3017 - Código: 10.282



TA 3007 / TA 3017

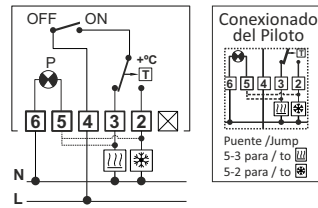

Heating Load, Cooling Load, Pilot Light

TA 3008 - Código: 10.097



TA 3018 - Código: 10.283



TA 3008

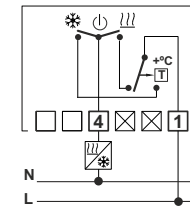

Hot, Cool, Heating Load, Cooling Load

Medidas / Measures

mm

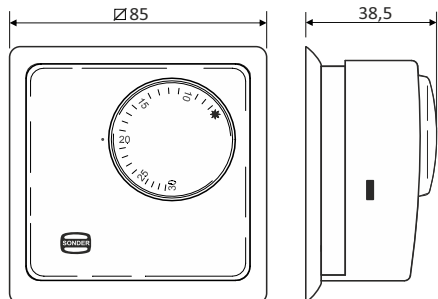

mm

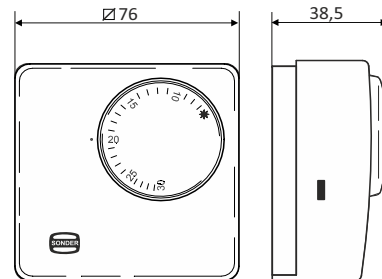

Accesorios / Accessories

PLACA TA - Código: 3.970



Included for: TA 3002, TA 3002 Braille, TA 3005, TA 3006, TA 3007, TA 3008

Optional for: TA 3012, TA 3017, TA 3018

mm

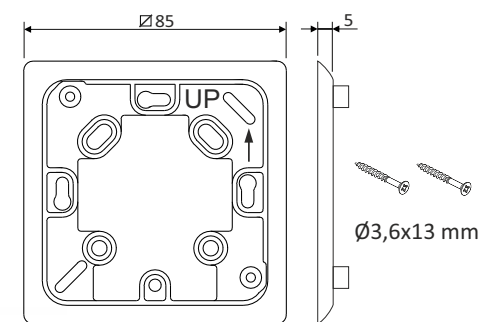

Ø3,6x13 mm